

CAMBRIAN INNOVATION

CLEAN WATER CLEAN ENERGY AS A SERVICE

Sustainable Wastewater Treatment Technology

Cambrian Provides Net-Zero Energy Wastewater Treatment with No Capital Required

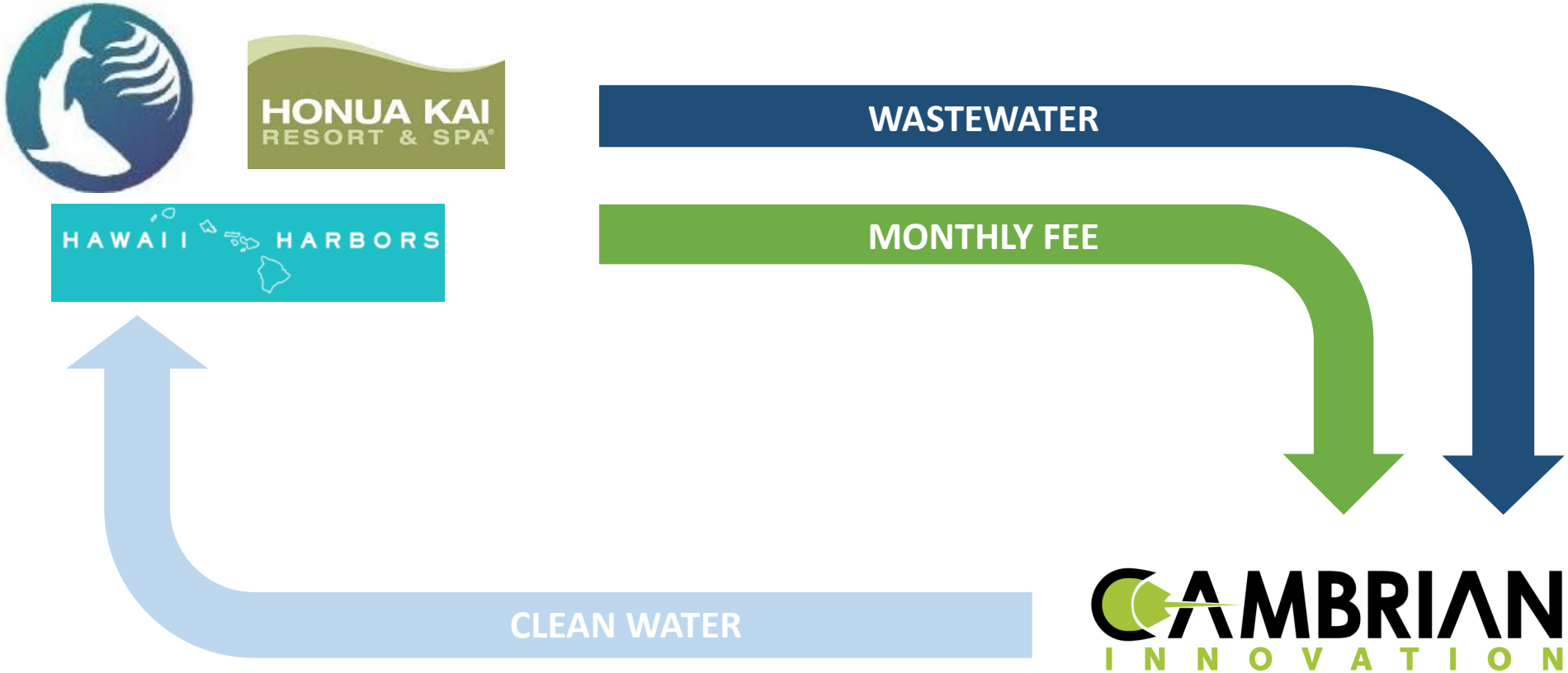

Scope of Supply

	Cambrian	Maalaea Community
Collection System		✓
Force Main		✓
Spray Irrigation		✓
Wastewater Treatment Plant	✓	
WWTP Engineering and Permitting	✓	
WWTP O&M	✓	
Asset Management	✓	

Design Basis

Parameter	Units	Influent	Effluent
Average Flow	gal/day	120,000	
Peak Factor	-	2.5x	
Maximum Daily Flow	gal/day	300,000	
BOD Concentration	mg/L	350	< 10
TSS Concentration	mg/L	350	< 10
TKN Concentration	mg/L	48	< 1

Process Flow Diagram

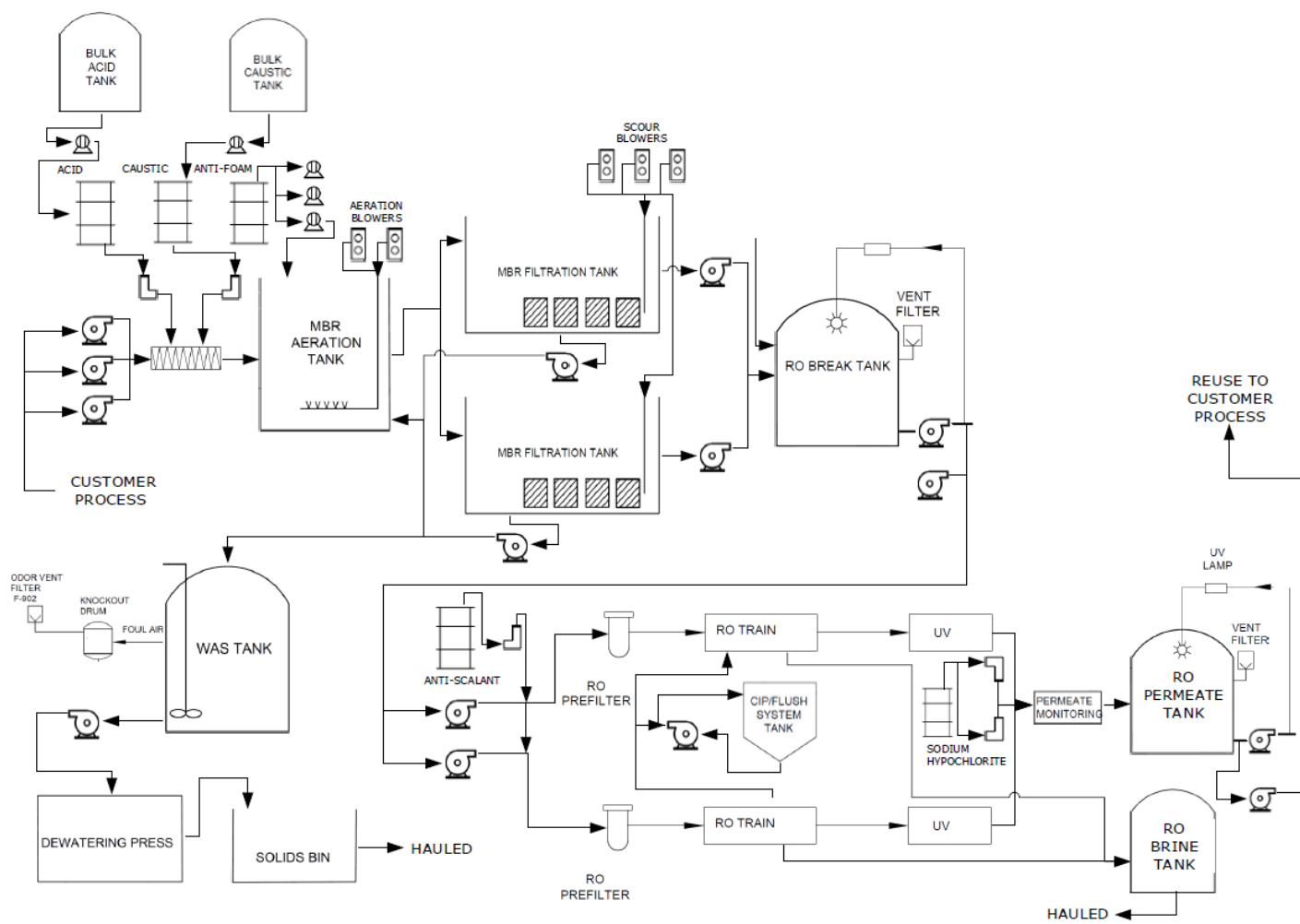

ECOVOLT MBR

MODULAR MEMBRANE BIOREACTOR

Fine-bubble diffusers for energy-efficient aeration and 99% BOD removal

Title 22-certified submerged, flat sheet, 0.08-micron membrane for 99% TSS removal

Solar array will completely offset the system's energy consumption, resulting in net-zero wastewater treatment

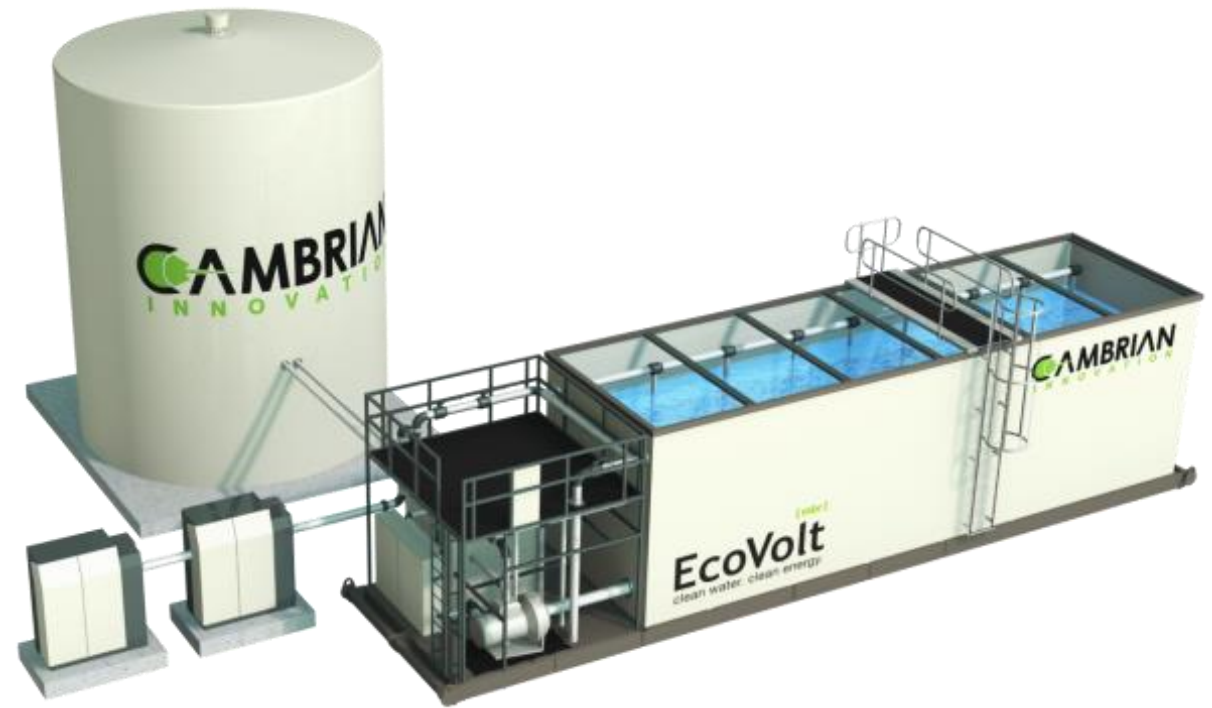

24/7 MONITORING & ANALYSIS

Seamless data integration
Intuitive and customizable dashboards
Live and historical data trending

REMOTE OPERATIONS

Accessible from any mobile device
Automated remote alerts and system health reporting

AUTOMATION & REAL-TIME OPTIMIZATION

Flow Logic™ — proprietary control module
Minimize energy use, operator oversight, and life-cycle costs
Maximize system performance and water recovery

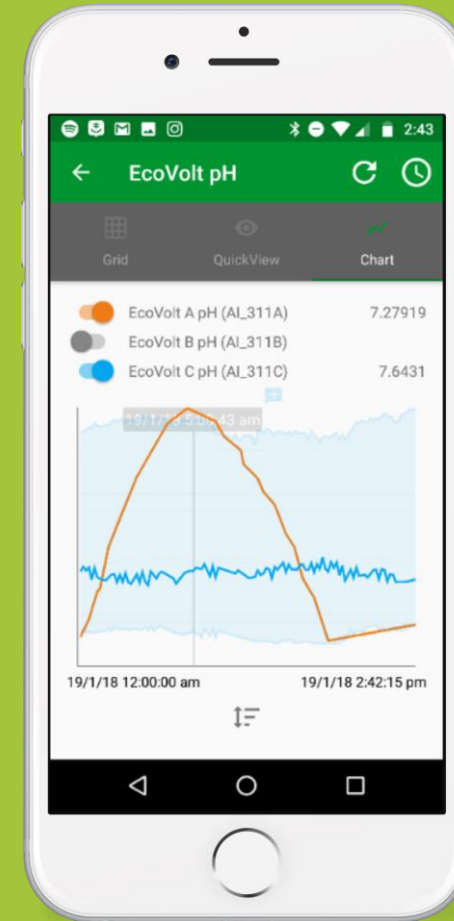

WEPA[®] for Maalaea Community

Parameter	Units	Value
Initial Term	years	20
Renewal Option	years	5
Optional Buyout	-	Fair Market Value
Annual Escalation	%	3
Take or Pay Treatment	gallons per month	3,650,000
Base WEPA Fee	\$/gal	\$0.013
EPC WEPA Fee	\$/gal	\$0.006

WEPA[®] Offers the Lowest Total Cost of Ownership

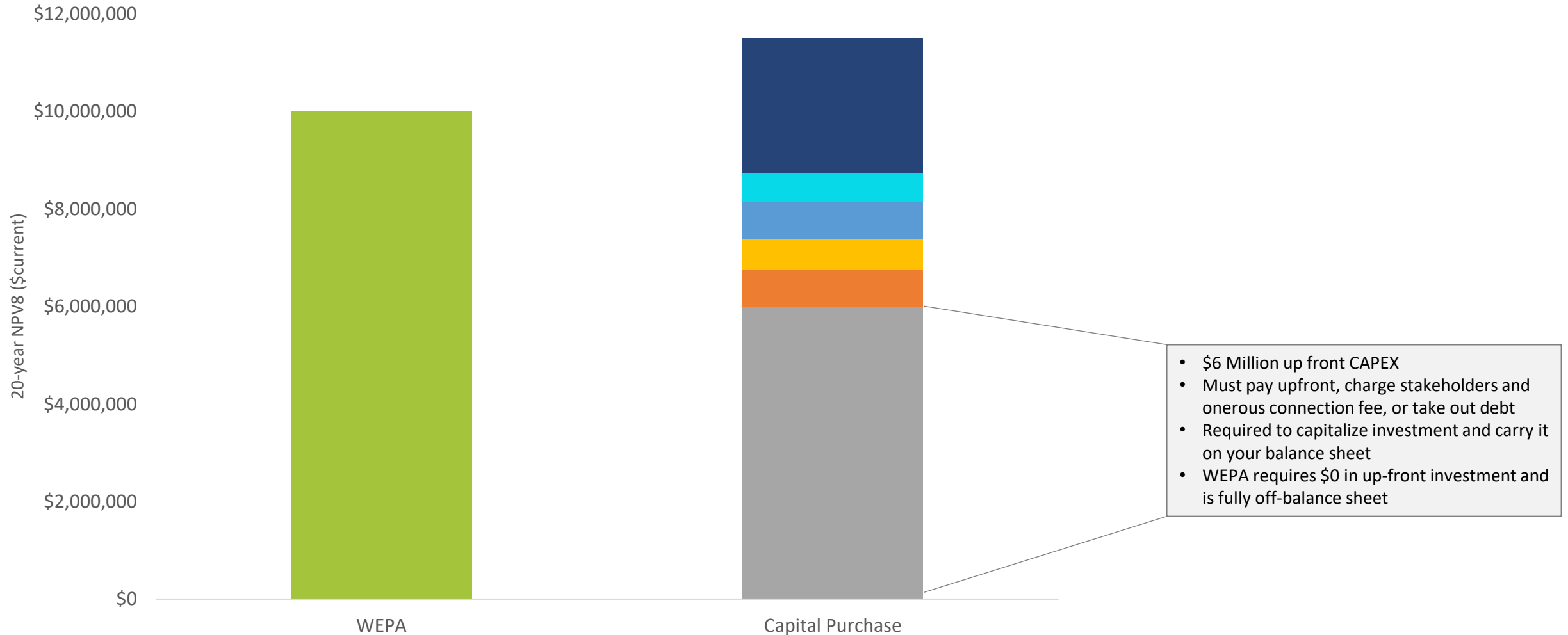

WEPA[®] Offers the Lowest Total Cost of Ownership

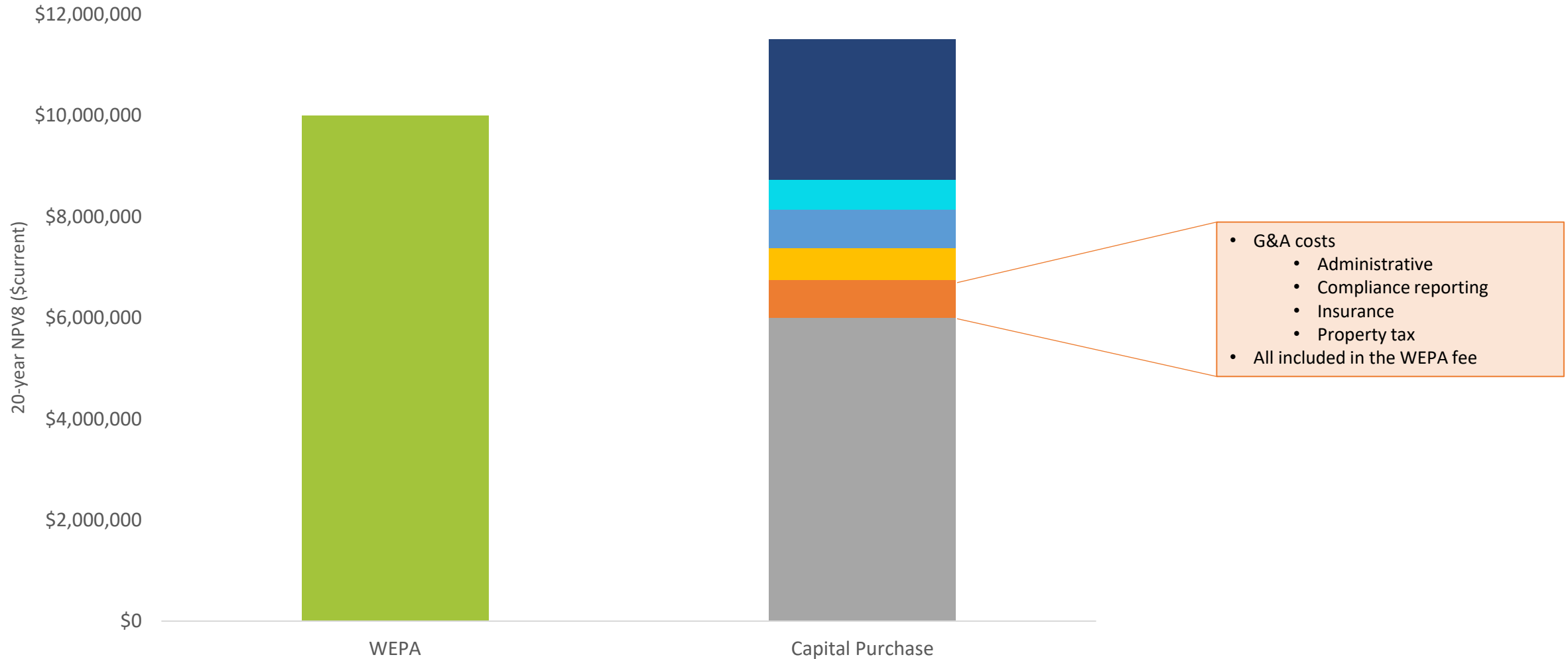

WEPA[®] Offers the Lowest Total Cost of Ownership

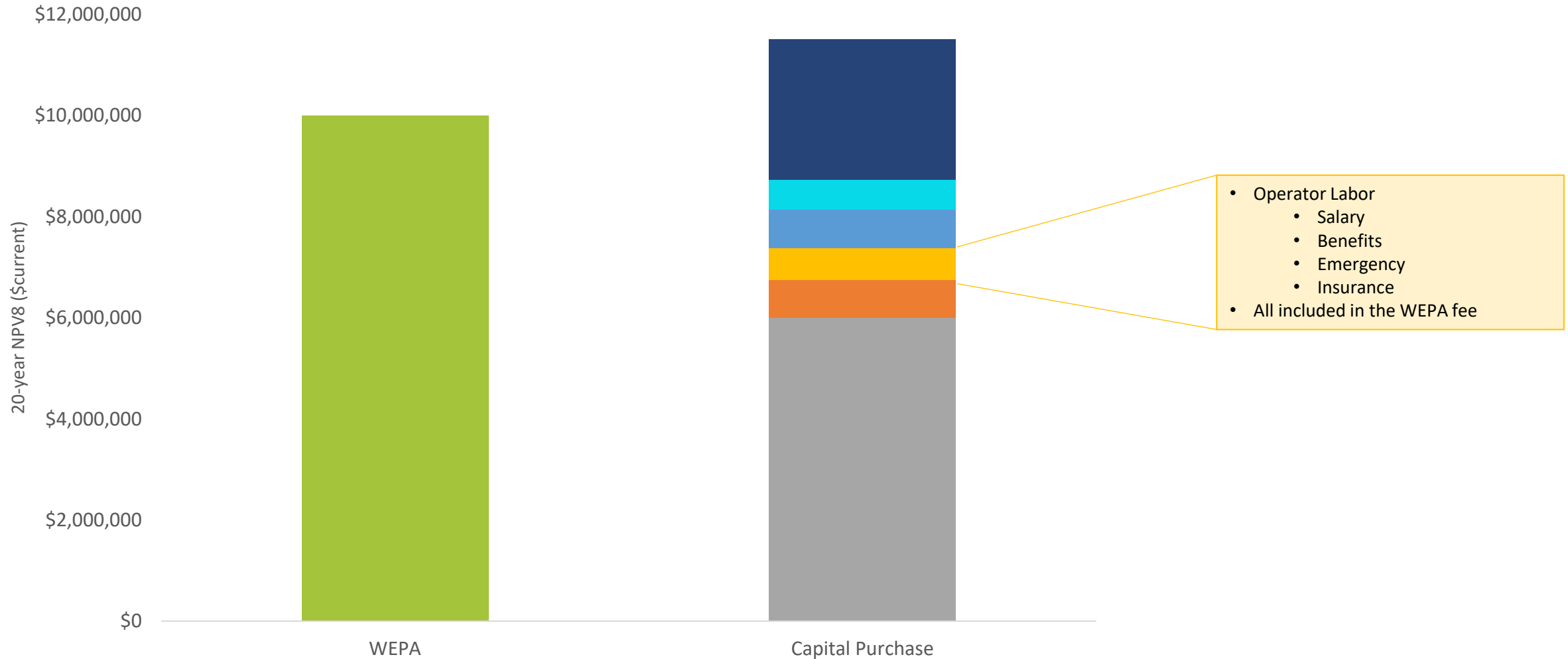

WEPA[®] Offers the Lowest Total Cost of Ownership

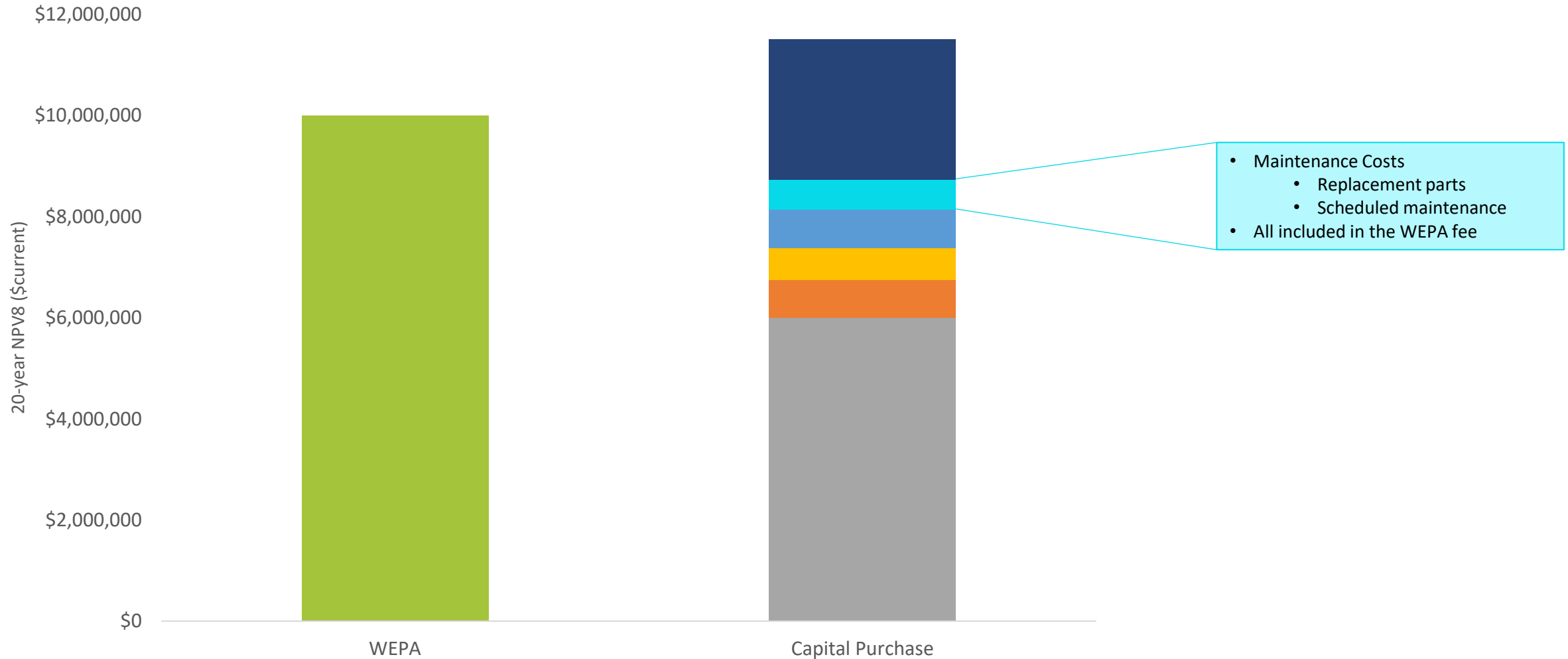

WEPA[®] Offers the Lowest Total Cost of Ownership

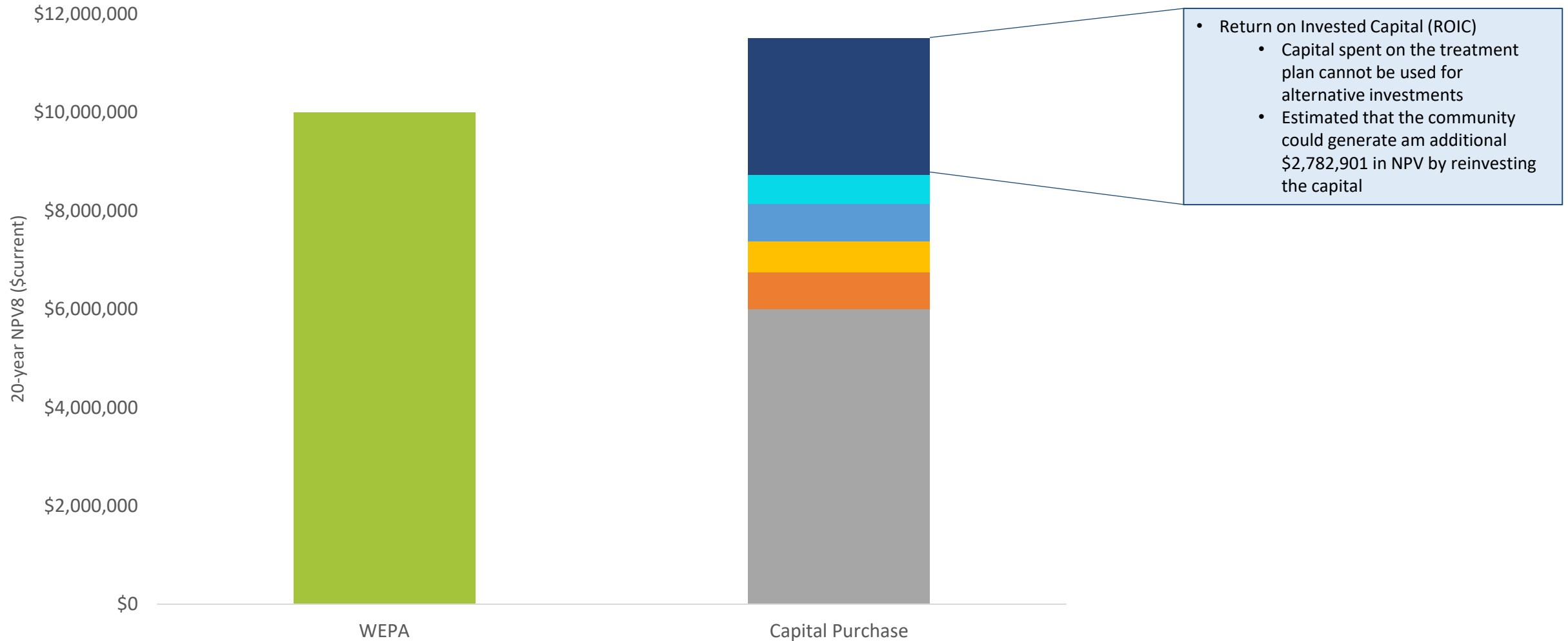

WEPA[®] Offers the Lowest Total Cost of Ownership

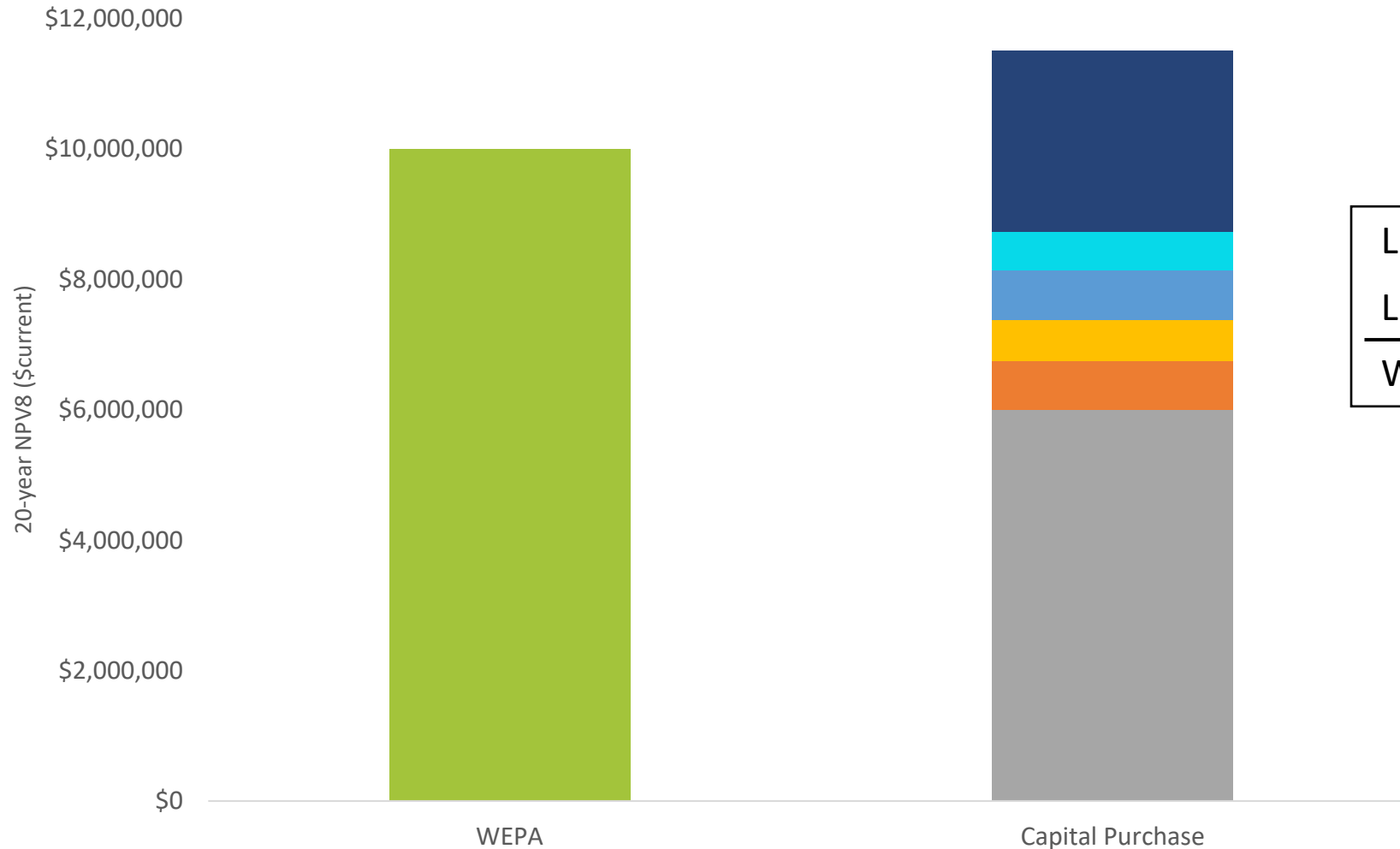

Lifetime WEPA NPV8	\$9,996,034
Lifetime CAPEX NPV8	\$11,514,512
<hr/>	
WEPA Savings NPV8	\$1,518,478

Other Benefits of the WEPA

PEACE OF MIND

Leave wastewater management to Cambrian and focus on your core competencies.

RISK-FREE OWNERSHIP AND OPERATION

Cambrian operates the system on your behalf. Helping you meet your operational and sustainability goals by producing renewable resources without sacrificing efficiency, valuable space, or capital.

PAY FOR PERFORMANCE

You only pay for performance.

SCALABLE WITH YOUR FACILITY

Solutions are containerized and modular, allowing for flexible capacity increase.



+1-617-307-1755

INFO@CAMBRIANINNOVATION.COM

CAMBRIANINNOVATION.COM